

100V N-Channel Enhancement Mode MOSFET

Description

The 50N10D uses advanced trench technology to provide excellent $R_{DS(ON)}$, low gate charge and operation with gate voltages as low as 4.5V.

This device is suitable for use as a Battery protection or in other Switching application.

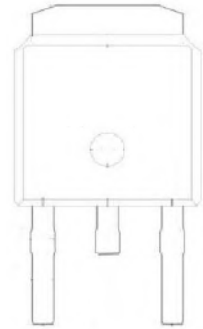
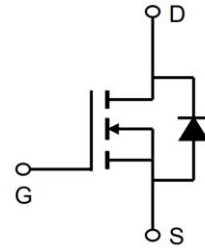

General Features

$V_{DS} = 100V$ $I_D = 50A$

$R_{DS(ON)} < 28m\Omega @ V_{GS}=10V$



Application

Battery protection

Load switch

Uninterruptible power supply

Package Marking and Ordering Information

Absolute Maximum Ratings ($T_c=25^\circ C$ unless otherwise noted)

Symbol	Parameter	Limit	Unit
V_{DS}	Drain-Source Voltage	100	V
V_{GS}	Gate-Source Voltage	± 20	V
I_D	Drain Current-Continuous	50	A
$I_D(100^\circ C)$	Drain Current-Continuous($T_C=100^\circ C$)	21	A
I_{DM}	Pulsed Drain Current	70	A
P_D	Maximum Power Dissipation	85	W
	Derating factor	0.57	W/ $^\circ C$
E_{AS}	Single pulse avalanche energy ^(Note 5)	256	mJ
T_J, T_{STG}	Operating Junction and Storage Temperature Range	-55 To 175	$^\circ C$
$R_{\theta JC}$	Thermal Resistance, Junction-to-Case ^(Note 2)	1.8	$^\circ C/W$

100V N-Channel Enhancement Mode MOSFET

Electrical Characteristics (T_c=25°C unless otherwise noted)

Symbol	Parameter	Condition	Min	Typ	Max	Unit
BV _{DSS}	Drain-Source Breakdown Voltage	V _{GS} =0V, I _D =250μA	100		-	V
IDSS	Zero Gate Voltage Drain Current	V _{DS} =100V, V _{GS} =0V	-	-	1	μA
IGSS	Gate-Body Leakage Current	V _{GS} =±20V, V _{DS} =0V	-	-	±100	nA
VGS(th)	Gate Threshold Voltage	V _{DS} =V _{GS} , I _D =250μA	1		3	V
RDS(ON)	Drain-Source On-State Resistance	V _{GS} =10V, I _D =20A	-	24	28	mΩ
RDS(ON)	Drain-Source On-State Resistance	V _{GS} =4.5V, I _D =10A	-	28	30	mΩ
gFS	Forward Transconductance	V _{DS} =5V, I _D =10A	-	15	-	S
C _{iss}	Input Capacitance	V _{DS} =25V, V _{GS} =0V, F=1.0MHz	-	2000	-	PF
C _{oss}	Output Capacitance		-	300	-	PF
C _{rss}	Reverse Transfer Capacitance		-	250	-	PF
td(on)	Turn-on Delay Time	V _{DD} =50V, R _L =5Ω V _{GS} =10V, R _{GEN} =3Ω	-	7	-	nS
t _r	Turn-on Rise Time		-	7	-	nS
td(off)	Turn-Off Delay Time		-	29	-	nS
t _f	Turn-Off Fall Time		-	7	-	nS
Q _g	Total Gate Charge	V _{DS} =50V, I _D =10A, V _{GS} =10V	-	39	-	nC
Q _{gs}	Gate-Source Charge		-	8	-	nC
Q _{gd}	Gate-Drain Charge		-	12	-	nC
VSD	Diode Forward Voltage ^(Note 3)	V _{GS} =0V, I _S =20A	-	-	1.2	V
I _S	Diode Forward Current ^(Note 2)	-	-	-	30	A
t _{rr}	Reverse Recovery Time	T _J = 25°C, I _F = 10A di/dt = 100A/μs ^(Note3)	-	32	-	nS
Q _{rr}	Reverse Recovery Charge		-	53	-	nC
ton	Forward Turn-On Time	Intrinsic turn-on time is negligible (turn-on is dominated by LS+LD)				

Notes:

- 1、Repetitive Rating: Pulse width limited by maximum junction temperature.
- 2、Surface Mounted on FR4 Board, t ≤ 10 sec.
- 3、Pulse Test: Pulse Width ≤ 300μs, Duty Cycle ≤ 2%.
- 4、Guaranteed by design, not subject to production
- 5、EAS Condition : T_j=25°C, V_{DD}=50V, V_G=10V, L=0.5mH, R_g=25Ω, I_{AS}=32A

100V N-Channel Enhancement Mode MOSFET

Typical Electrical and Thermal Characteristics (Curves)

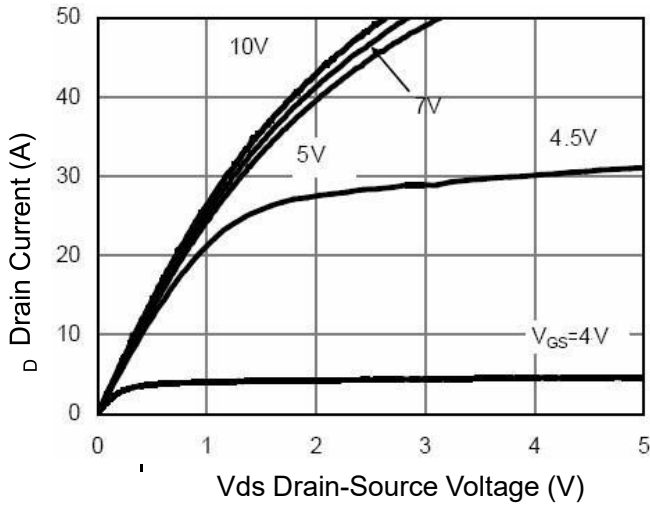

Figure 1 Output Characteristics

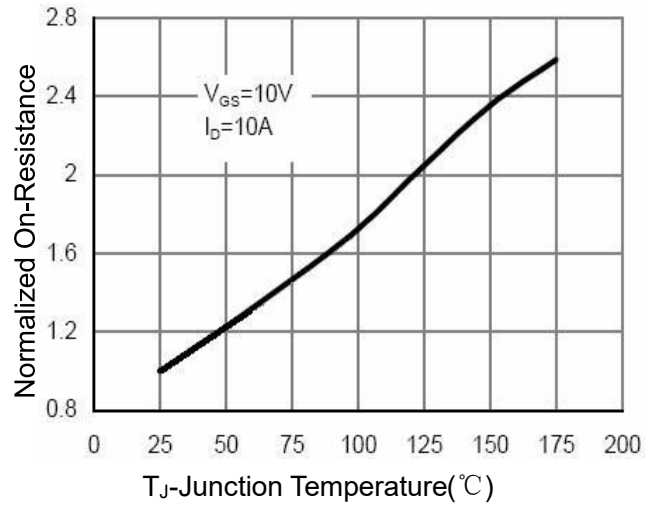

Figure 4 Rdson-Junction Temperature

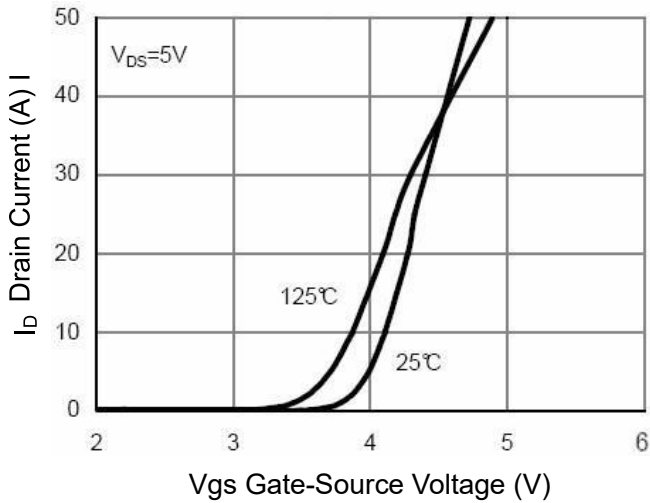

Figure 2 Transfer Characteristics

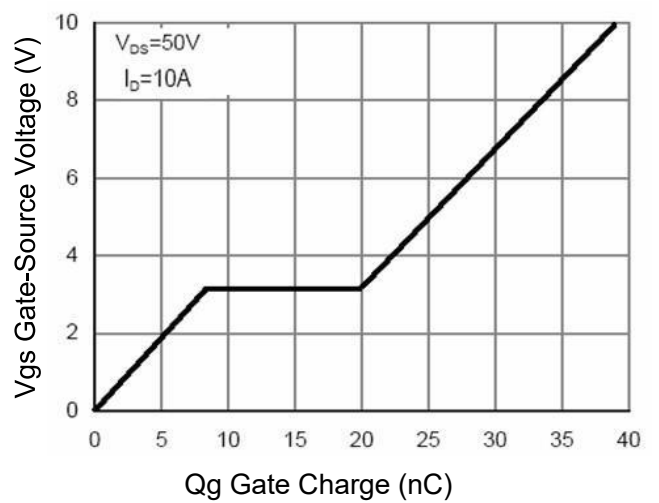

Figure 5 Gate Charge

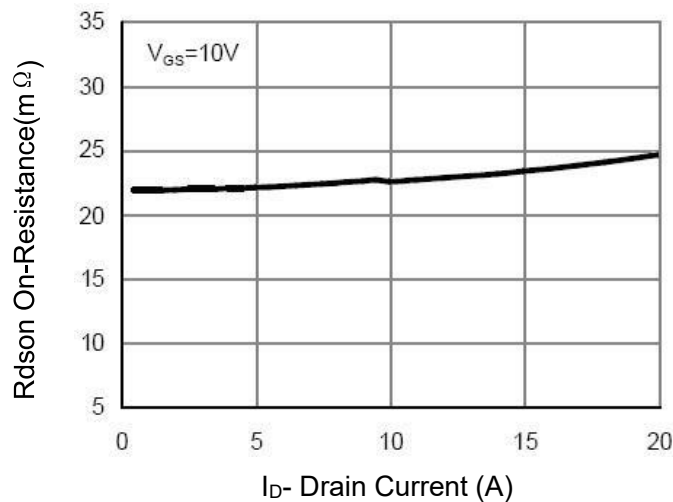

Figure 3 Rdson- Drain Current

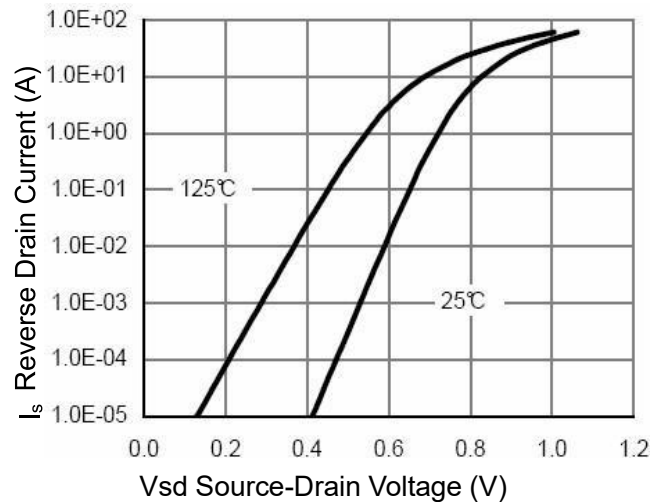

Figure 6 Source- Drain Diode Forward

100V N-Channel Enhancement Mode MOSFET

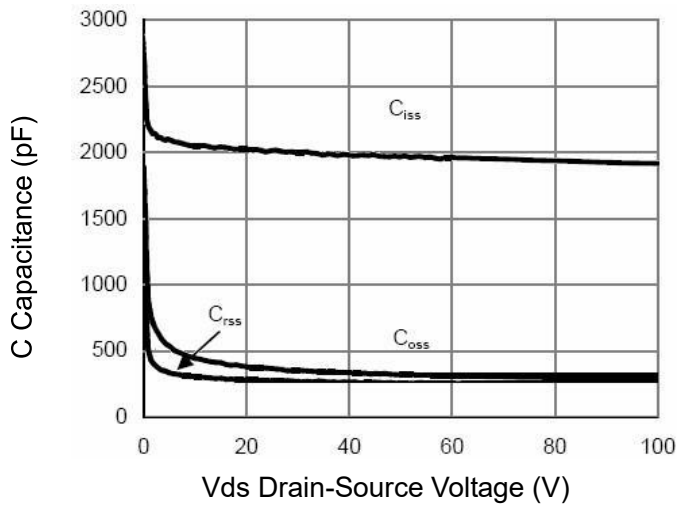

Figure 7 Capacitance vs Vds

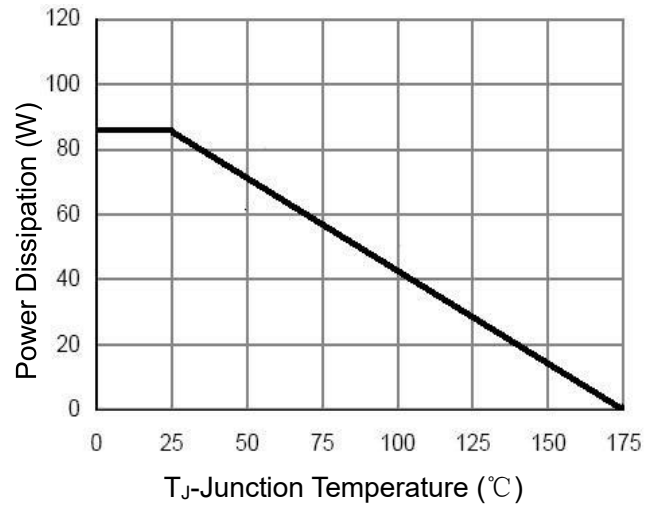

Figure 9 Power De-rating

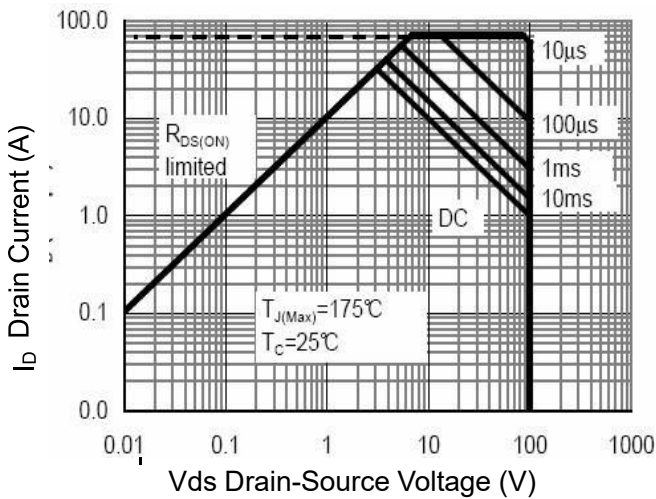

Figure 8 Safe Operation Area

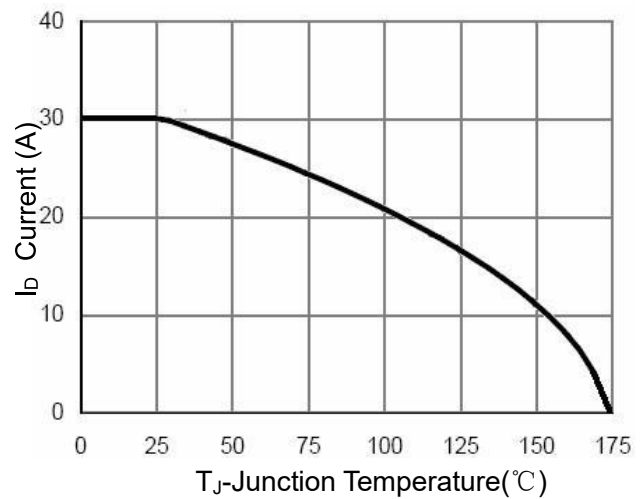

Figure 10 ID Current- Junction Temperature

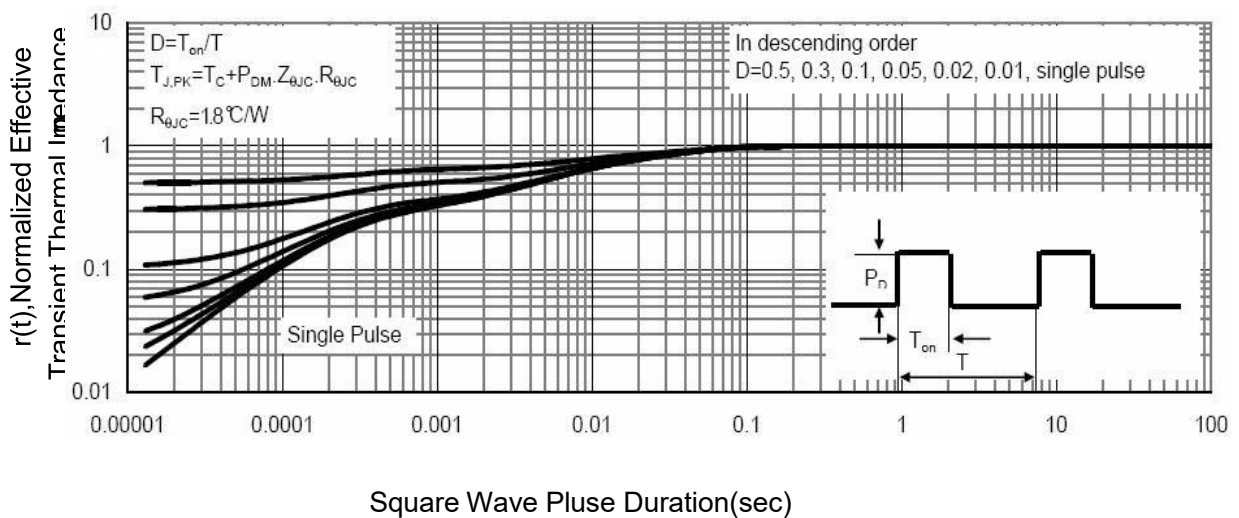
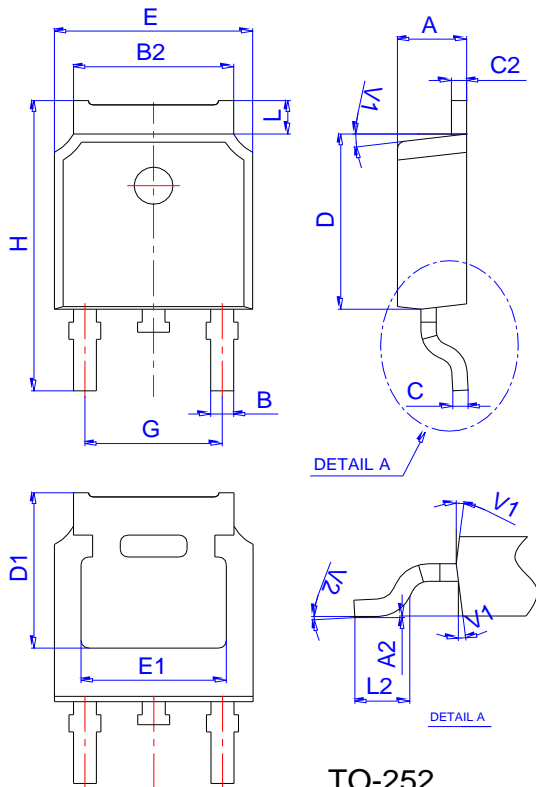

Figure 11 Normalized Maximum Transient Thermal Impedance

100V N-Channel Enhancement Mode MOSFET

Package Mechanical Data TO-252-3L



Ref.	Dimensions					
	Millimeters			Inches		
	Min.	Typ.	Max.	Min.	Typ.	Max.
A	2.10		2.50	0.083		0.098
A2	0		0.10	0		0.004
B	0.66		0.86	0.026		0.034
B2	5.18		5.48	0.202		0.216
C	0.40		0.60	0.016		0.024
C2	0.44		0.58	0.017		0.023
D	5.90		6.30	0.232		0.248
D1	5.30REF			0.209REF		
E	6.40		6.80	0.252		0.268
E1	4.63			0.182		
G	4.47		4.67	0.176		0.184
H	9.50		10.70	0.374		0.421
L	1.09		1.21	0.043		0.048
L2	1.35		1.65	0.053		0.065
V1		7°			7°	
V2	0°		6°	0°		6°

Reel Specification-TO-252

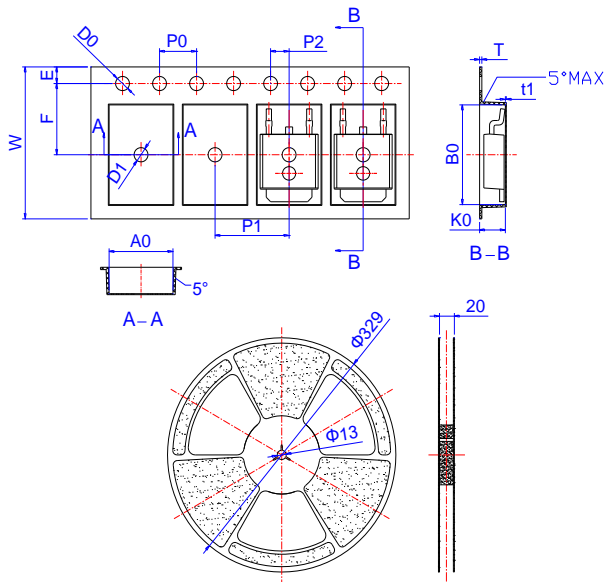

Ref.	Dimensions					
	Millimeters			Inches		
	Min.	Typ.	Max.	Min.	Typ.	Max.
W	15.90	16.00	16.10	0.626	0.630	0.634
E	1.65	1.75	1.85	0.065	0.069	0.073
F	7.40	7.50	7.60	0.291	0.295	0.299
D0	1.40	1.50	1.60	0.055	0.059	0.063
D1	1.40	1.50	1.60	0.055	0.059	0.063
P0	3.90	4.00	4.10	0.154	0.157	0.161
P1	7.90	8.00	8.10	0.311	0.315	0.319
P2	1.90	2.00	2.10	0.075	0.079	0.083
A0	6.85	6.90	7.00	0.270	0.271	0.276
B0	10.45	10.50	10.60	0.411	0.413	0.417
K0	2.68	2.78	2.88	0.105	0.109	0.113
T	0.24		0.27	0.009		0.011
t1	0.10			0.004		
10P0	39.80	40.00	40.20	1.567	1.575	1.583